

**STANDARD PROFILE KNIVES IN "SP" STEEL - height 40x4 mm  
(RELATING LIMITERS)**

**Example:  
Knife SA0..  
Limiter (SA1..)**

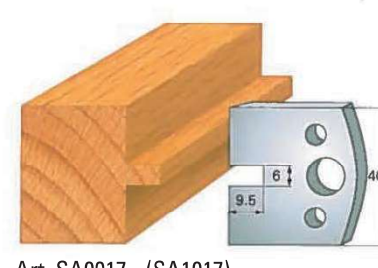
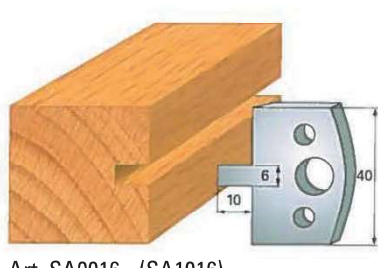
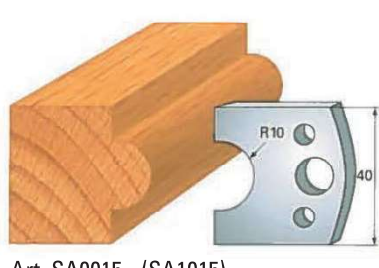
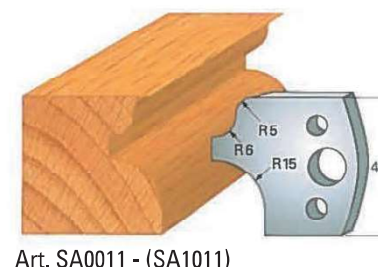
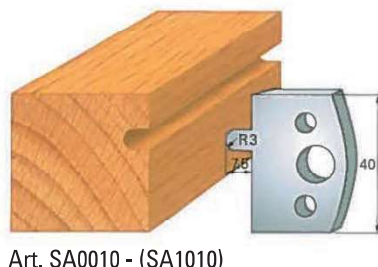
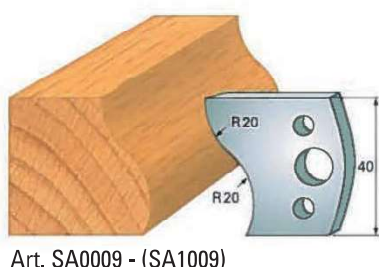
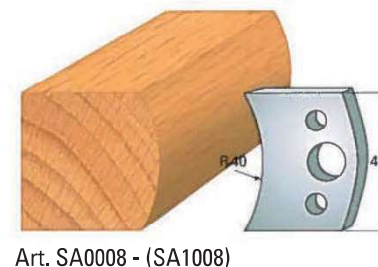
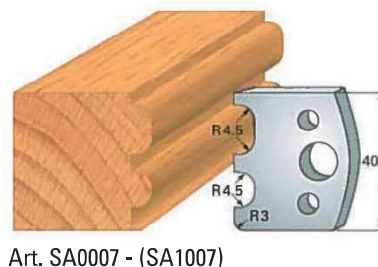
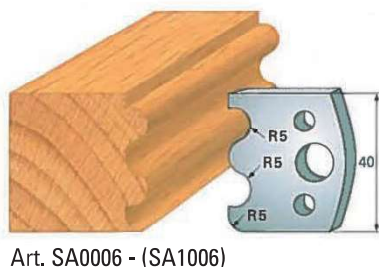
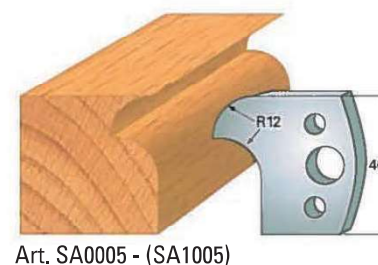
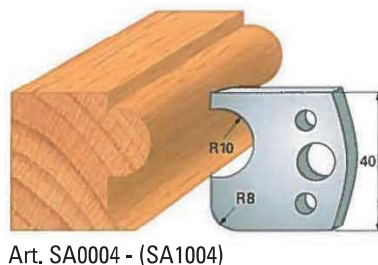
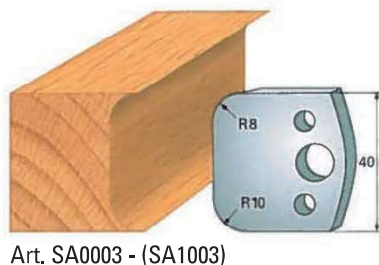
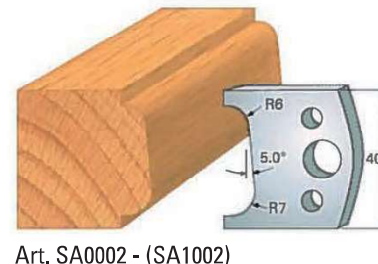
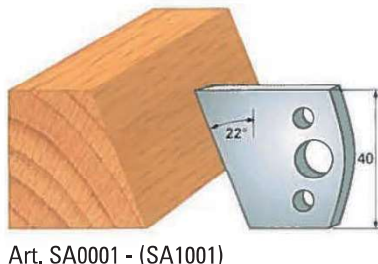
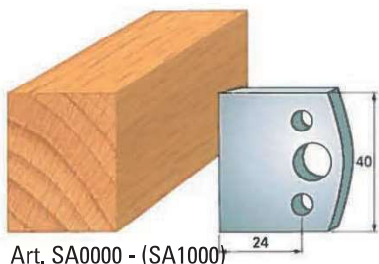

**STANDARD PROFILE KNIVES IN "SP" STEEL - height 40x4 mm  
(RELATING LIMITERS)**

**Example:  
Knife SA0..  
Limiter (SA1..)**

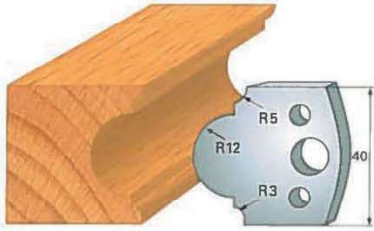

Art. SA0018 - (SA1018)

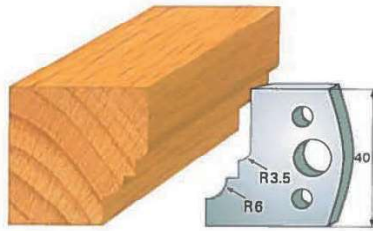

Art. SA0019 - (SA1019)

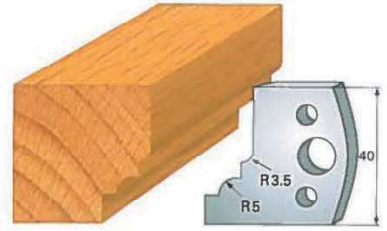

Art. SA0020 - (SA1020)

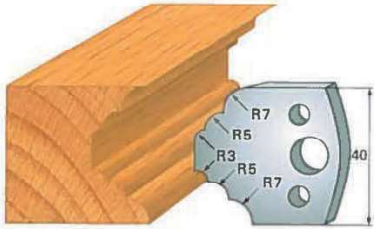

Art. SA0021 - (SA1021)

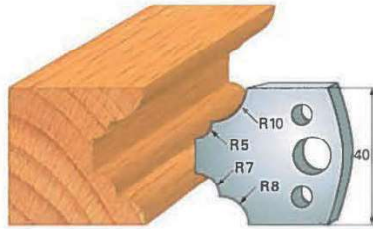

Art. SA0022 - (SA1022)

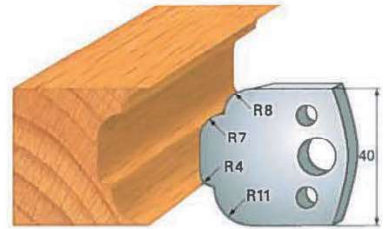

Art. SA0023 - (SA1023)

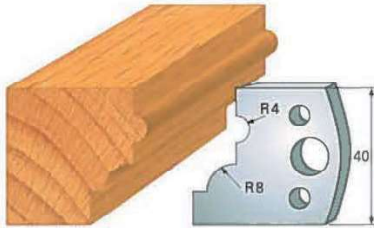

Art. SA0024 - (SA1024)

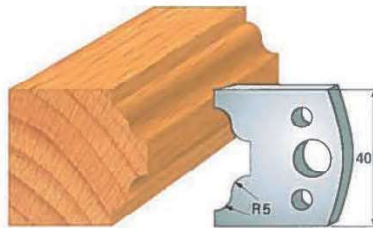

Art. SA0025 - (SA1025)

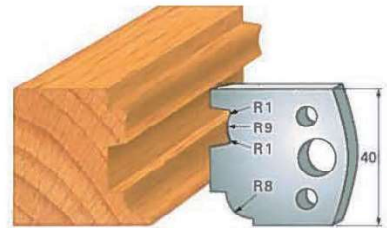

SA0026 - (SA1026)

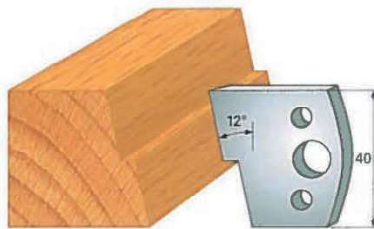

Art. SA0027 - (SA1027)



Art. SA0028 - (SA1028)

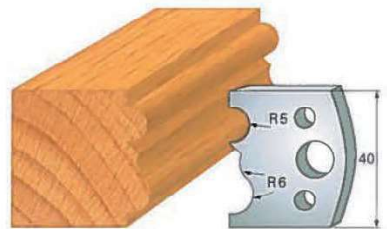

Art. SA0029 - (SA1029)

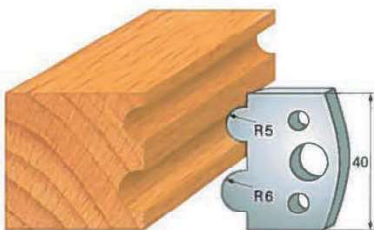

Art. SA0030 - (SA1030)

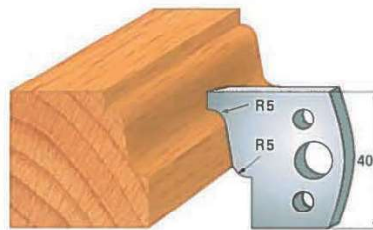

Art. SA0031 - (SA1031)

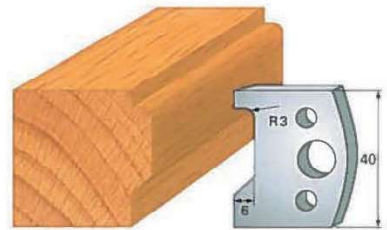

Art. SA0032 - (SA1032)

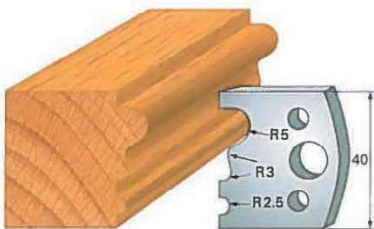

Art. SA0033 - (SA1033)

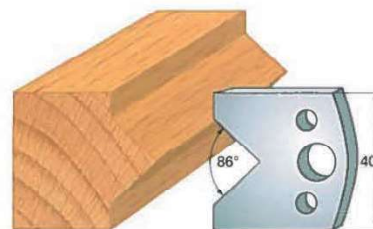

Art. SA0034 - (SA1034)

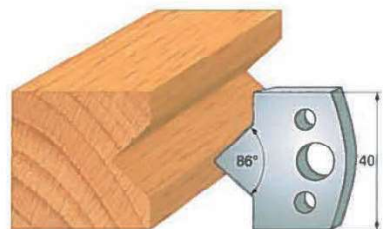

Art. SA0035 - (SA1035)

**STANDARD PROFILE KNIVES IN "SP" STEEL - height 40x4 mm  
(RELATING LIMITERS)**

**Example:  
Knife SA0..  
Limiter (SA1..)**

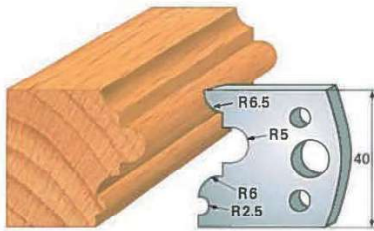

Art. SA0036 - (SA1036)

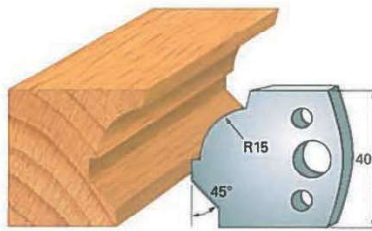

Art. SA0037 - (SA1037)

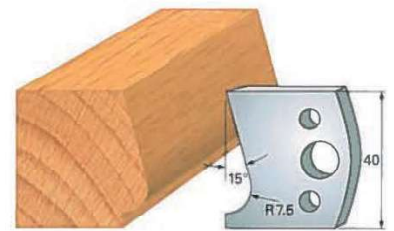

Art. SA0038 - (SA1038)

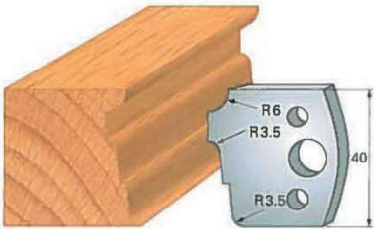

Art. SA0039 - (SA1039)

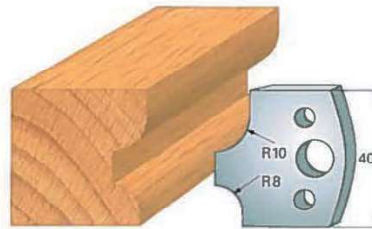

Art. SA0040 - (SA1040)

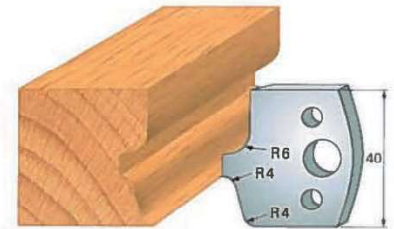

Art. SA0041 - (SA1041)

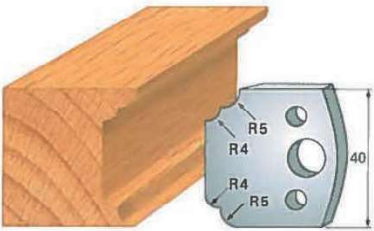

Art. SA0042 - (SA1042)

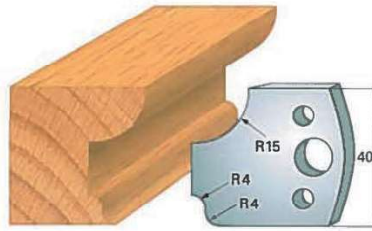

Art. SA0043 - (SA1043)

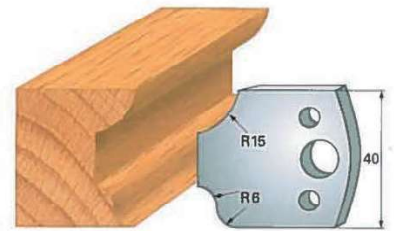

Art. SA0044 - (SA1044)

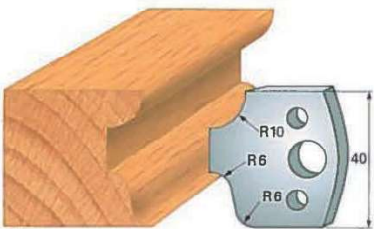

Art. SA0045 - (SA1045)

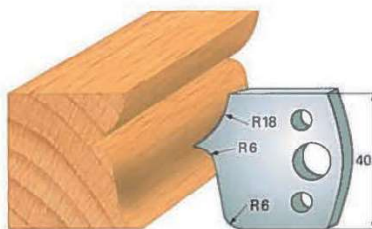

Art. SA0046 - (SA1046)

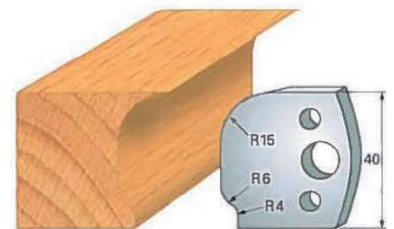

Art. SA0047 - (SA1047)

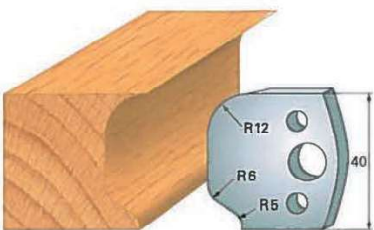

Art. SA0048 - (SA1048)

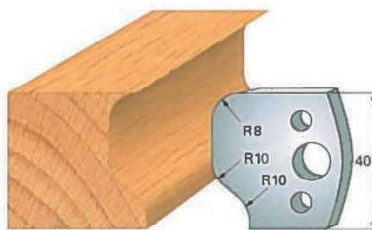

Art. SA0049 - (SA1049)

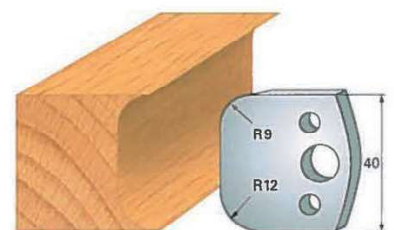

Art. SA0050 - (SA1050)

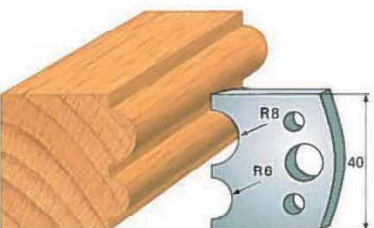

Art. SA0051 - (SA1051)

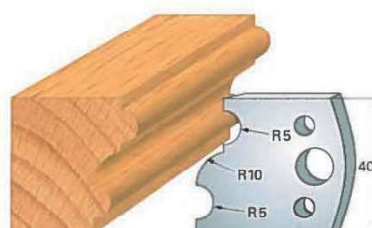

Art. SA0052 - (SA1052)

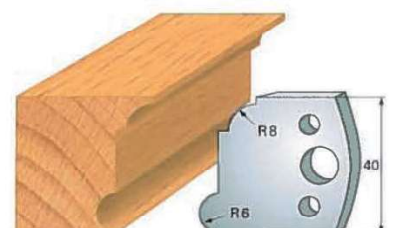

Art. SA0053 - (SA1053)

**STANDARD PROFILE KNIVES IN "SP" STEEL - height 40x4 mm  
(RELATING LIMITERS)**

**Example:  
Knife SA0..  
Limiter (SA1..)**

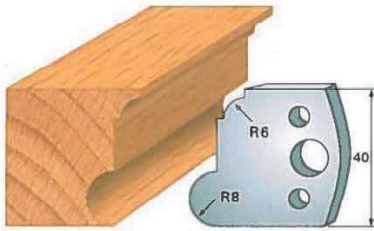

Art. SA0054 - (SA1054)

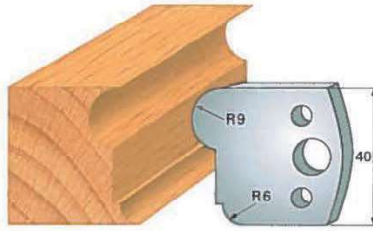

Art. SA0055 - (SA1055)

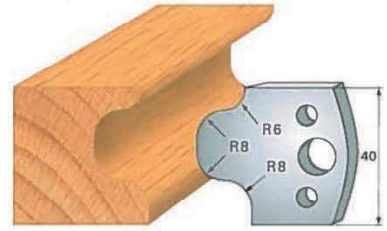

Art. SA0056 - (SA1056)

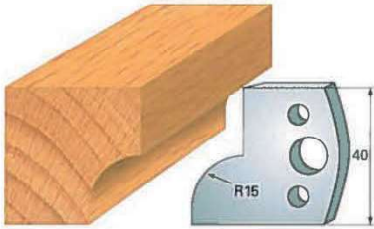

Art. SA0057 - (SA1057)

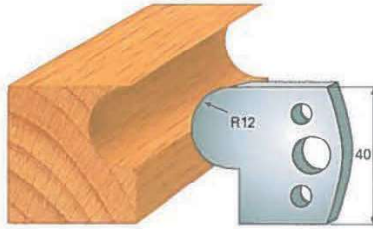

Art. SA0058 - (SA1058)

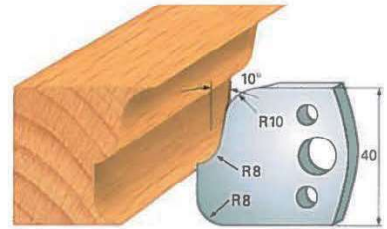

Art. SA0059 - (SA1059)

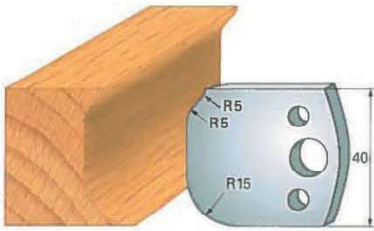

Art. SA0060 - (SA1060)

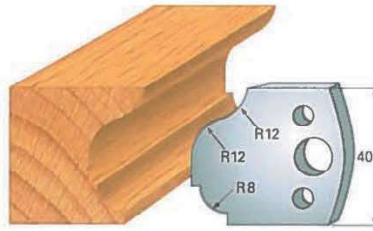

Art. SA0061 - (SA1061)

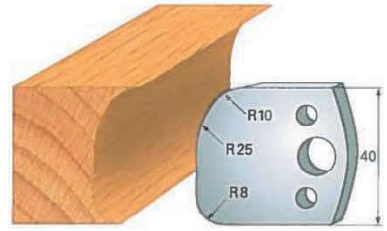

Art. SA0062 - (SA1062)

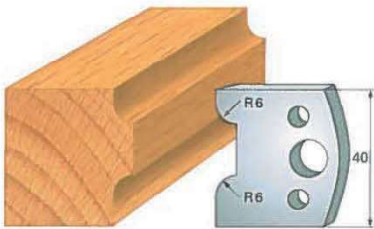

Art. SA0063 - (SA1063)

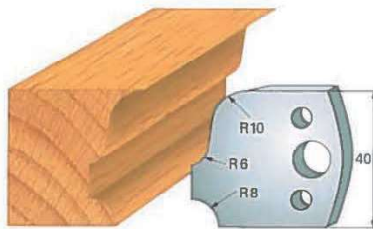

Art. SA0064 - (SA1064)

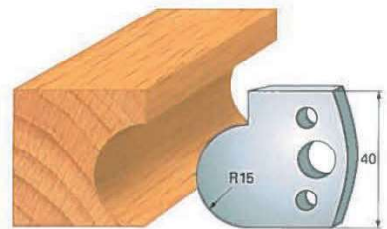

Art. SA0065 - (SA1065)

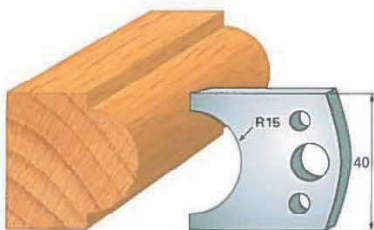

Art. SA0066 - (SA1066)

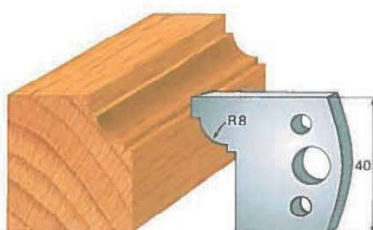

Art. SA0067 - (SA1067)

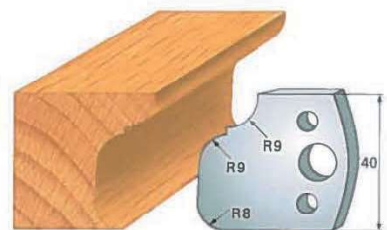

Art. SA0068 - (SA1068)

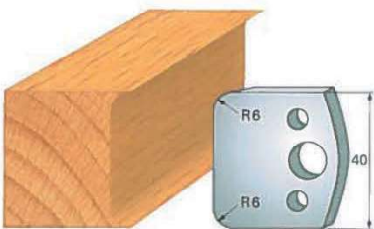

Art. SA0069 - (SA1069)

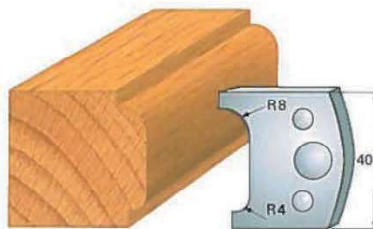

Art. SA0070 - (SA1070)

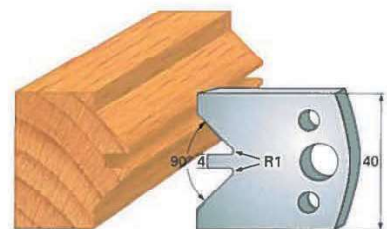

Art. SA0071 - (SA1071)

**STANDARD PROFILE KNIVES IN "SP" STEEL - height 40x4 mm  
(RELATING LIMITERS)**

**Example:  
Knife SA0..  
Limiter (SA1..)**

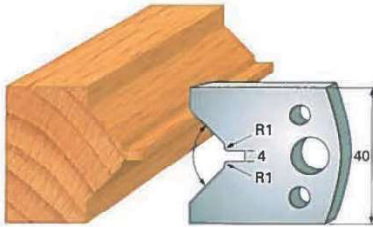

Art. SA0072 - (SA1072)

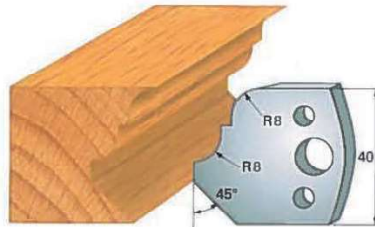

Art. SA0073 - (SA1073)



Art. SA0074 - (SA1074)

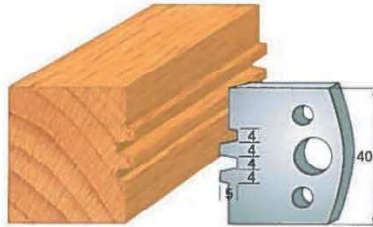

Art. SA0075 - (SA1075)

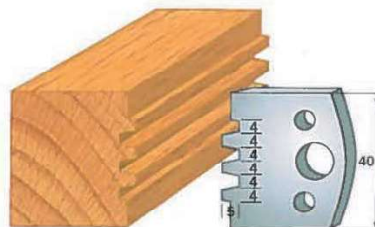

Art. SA0076 - (SA1076)

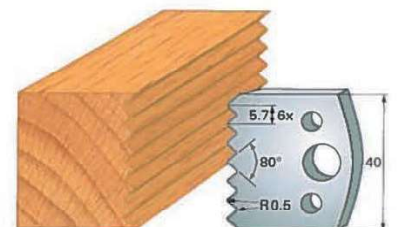

Art. SA0077 - (SA1077)

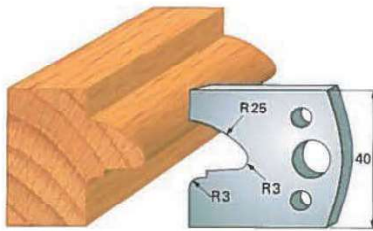

Art. SA0078 - (SA1078)

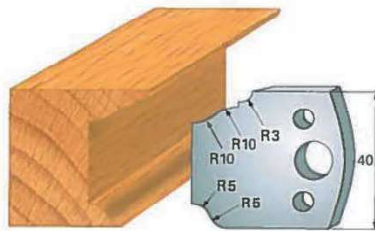

Art. SA0079 - (SA1079)

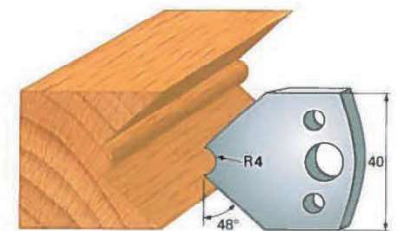

Art. SA0080 - (SA1080)

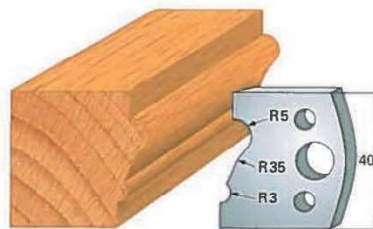

Art. SA0081 - (SA1081)

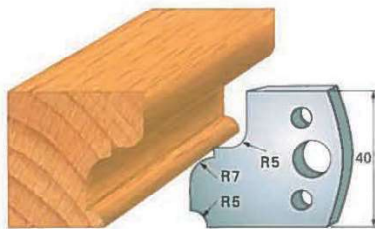

Art. SA0082 - (SA1082)

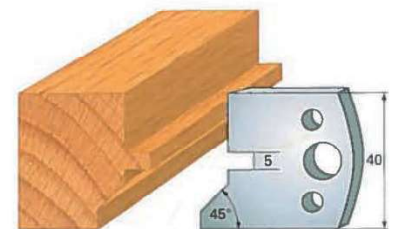

Art. SA0083 - (SA1083)

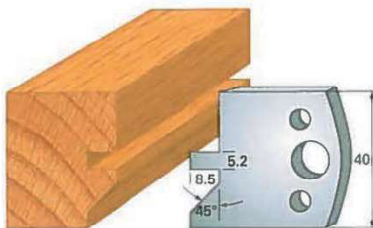

Art. SA0084 - (SA1084)

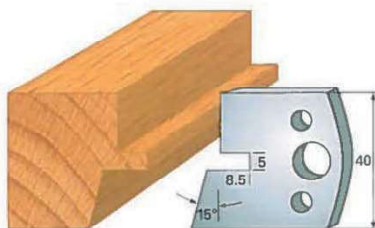

Art. SA0085 - (SA1085)

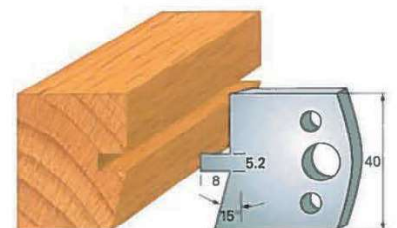

Art. SA0086 - (SA1086)

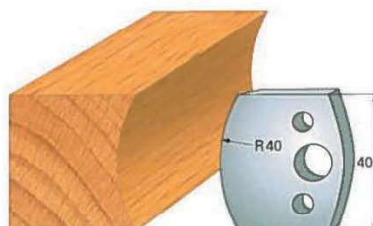

Art. SA0087 - (SA1087)

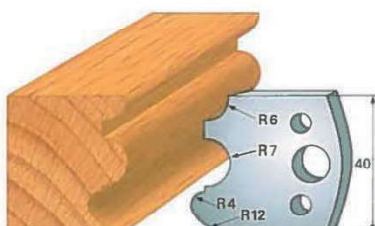

Art. SA0088 - (SA1088)

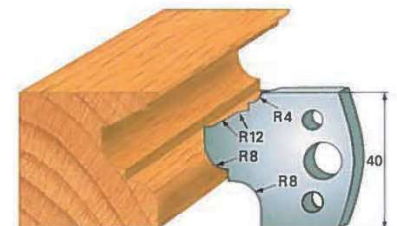

Art. SA0089 - (SA1089)

**STANDARD PROFILE KNIVES IN "SP" STEEL - height 40x4 mm  
(RELATING LIMITERS)**

**Example:  
Knife SA0..  
Limiter (SA1..)**

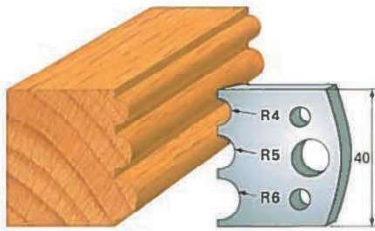

Art. SA0090 - (SA1090)

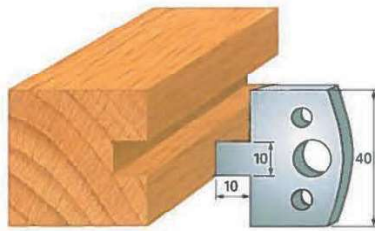

Art. SA0091 - (SA1091)

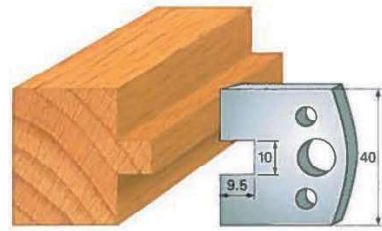

Art. SA0092 - (SA1092)

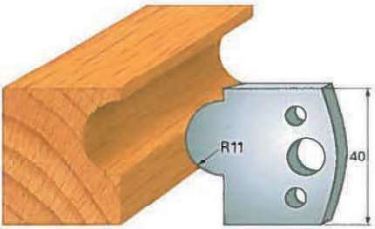

Art. SA0093 - (SA1093)

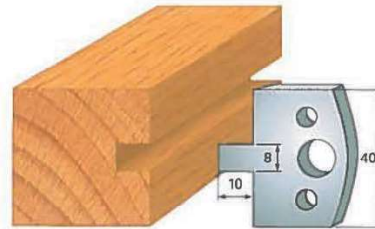

Art. SA0094 - (SA1094)

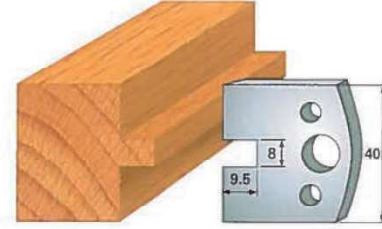

Art. SA0095 - (SA1095)

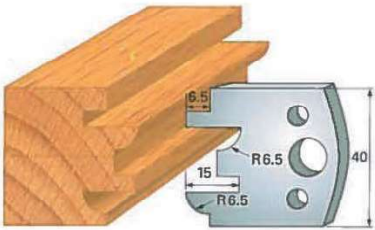

Art. SA0096 - (SA1096)

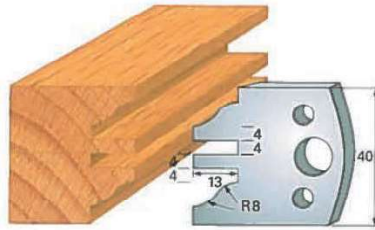

Art. SA0097 - (SA1097)

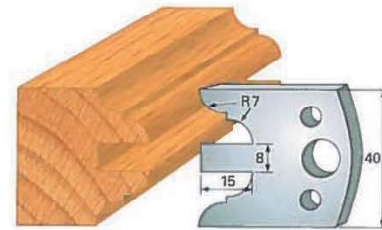

Art. SA0098 - (SA1098)

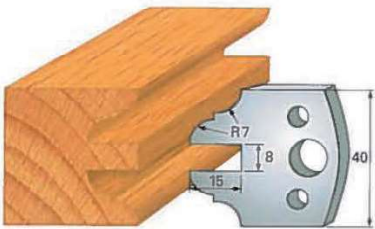

Art. SA0099 - (SA1099)

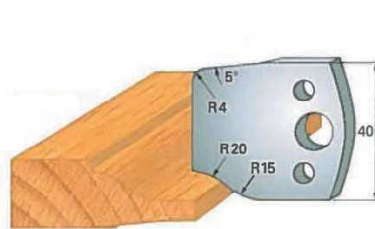

Art. SA0100 - (SA1100)

**STANDARD PROFILE KNIVES IN "SP" STEEL - height 50x4 mm  
(RELATING LIMITERS)**

**Example:  
Knife SA2..  
Limiter (SA3..)**

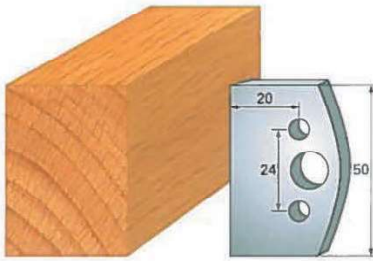

Art. SA2000 - (SA3000)

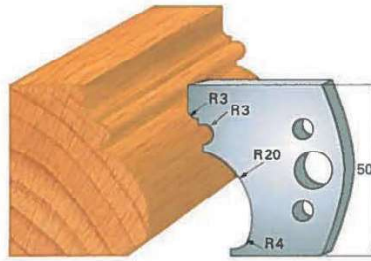

Art. SA2001 - (SA3001)

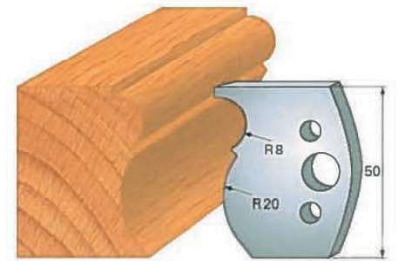

Art. SA2002 - (SA3002)

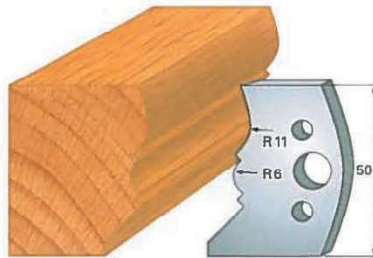

Art. SA2003 - (SA3003)

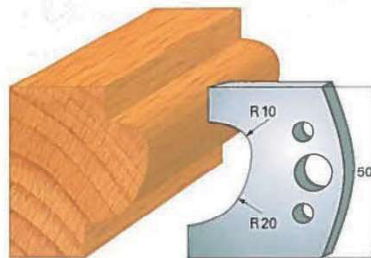

Art. SA2004 - (SA3004)

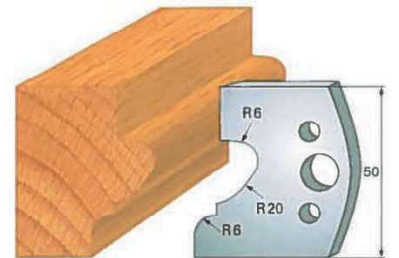

Art. SA2005 - (SA3005)

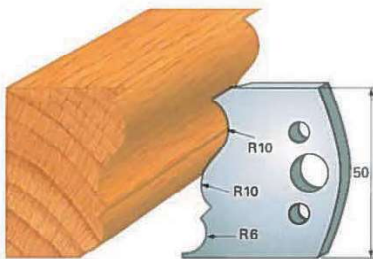

Art. SA2006 - (SA3006)

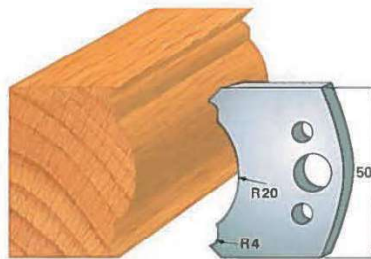

Art. SA2007 - (SA3007)

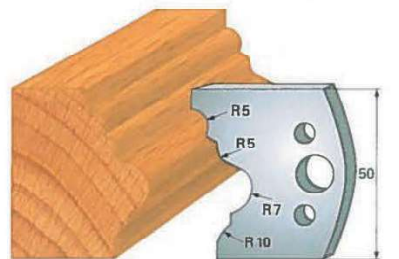

Art. SA2008 - (SA3008)

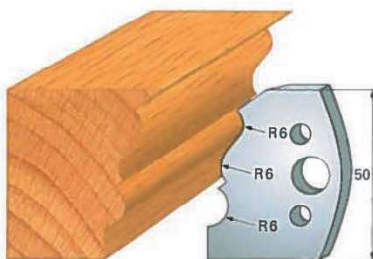

Art. SA2009 - (SA3009)

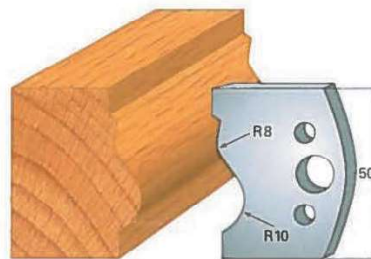

Art. SA2010 - (SA3010)

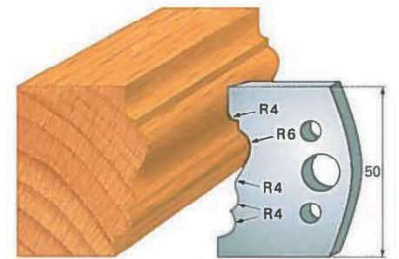

Art. SA2011 - (SA3011)

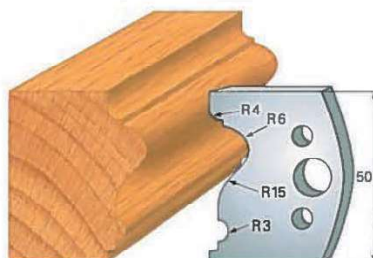

Art. SA2012 - (SA3012)

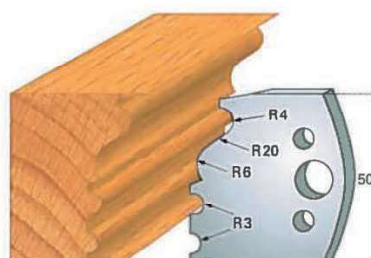

Art. SA2013 - (SA3013)

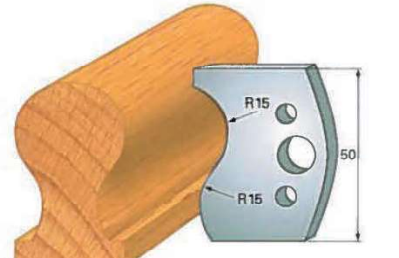

Art. SA2014 - (SA3014)

**STANDARD PROFILE KNIVES IN "SP" STEEL - height 50x4 mm  
(RELATING LIMITERS)**

**Example:  
Knife SA2..  
Limiter (SA3..)**

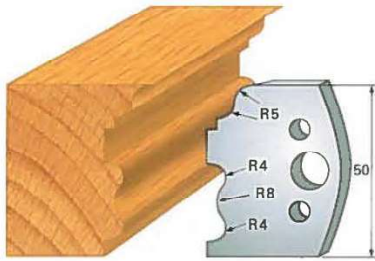

Art. SA2015 - (SA3015)

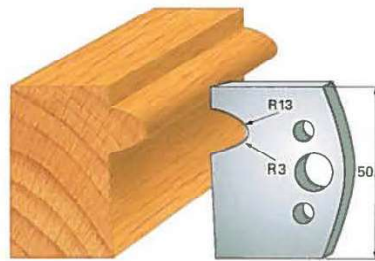

Art. SA2016 - (SA3016)

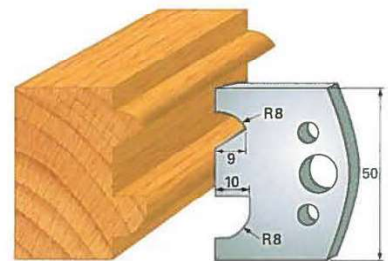

Art. SA2017 - (SA3017)

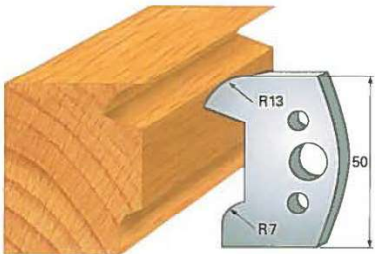

Art. SA2018 - (SA3018)

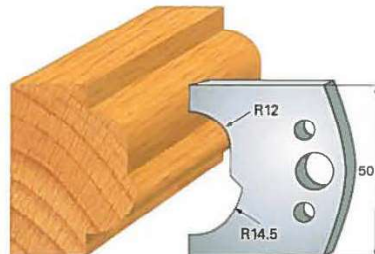

Art. SA2019 - (SA3019)

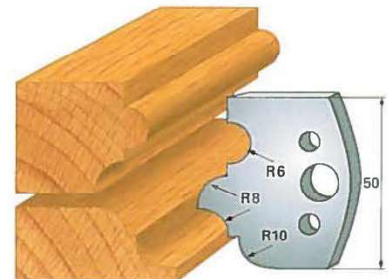

Art. SA2020 - (SA3020)

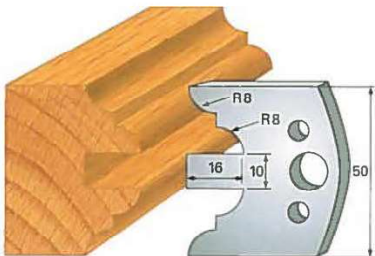

Art. SA2022 - (SA3022)

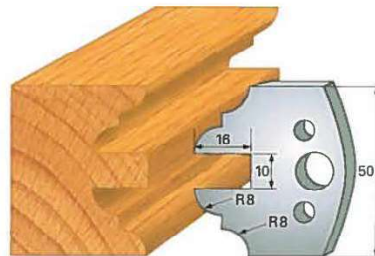

Art. SA2023 - (SA3023)

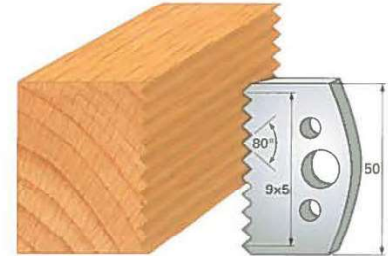

Art. SA2024 - (SA3024)

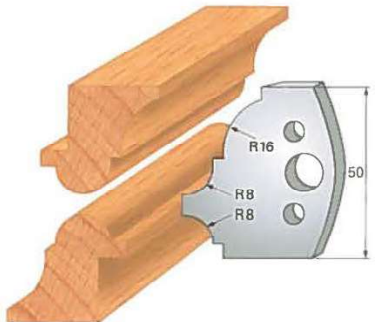

Art. SA2041 - (SA3041)

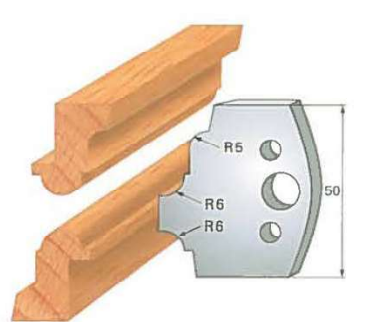

Art. SA2042 - (SA3042)

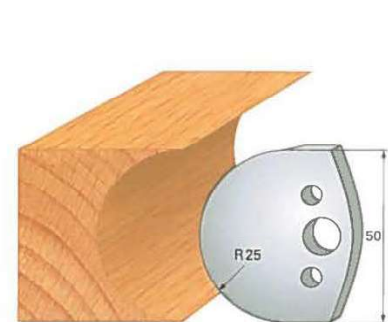

Art. SA2043 - (SA3043)



Art. SA2044 - (SA3044)



Art. SA2045 - (SA3045)

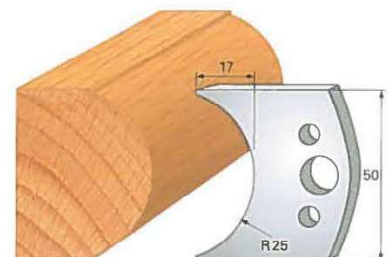

Art. SA2046 - (SA3046)



**STANDARD PROFILE KNIVES IN "SP" STEEL - height 50x4 mm  
(RELATING LIMITERS)**

**Example:  
Knife SA2..  
Limiter (SA3..)**



Art. SA2047 - (SA3047)



Art. SA2048 - (SA3048)



Art. SA2049 - (SA3049)

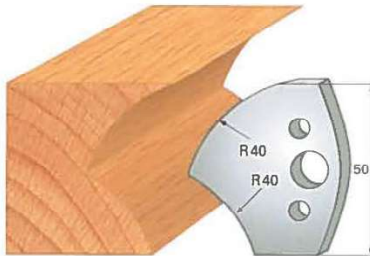

Art. SA2050 - (SA3050)

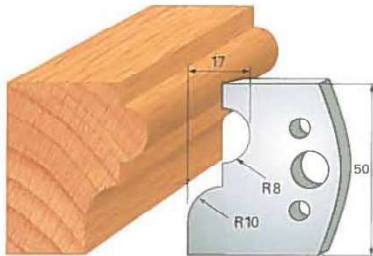

Art. SA2051 - (SA3051)

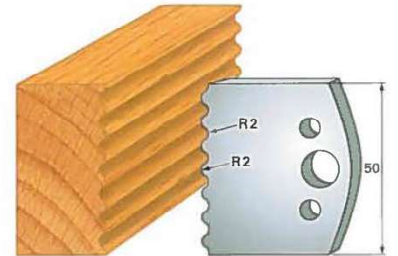

Art. SA2052 - (SA3052)



Art. SA2053 - (SA3053)

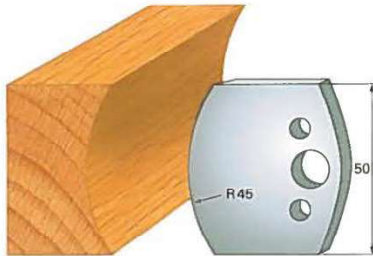

Art. SA2054 - (SA3054)

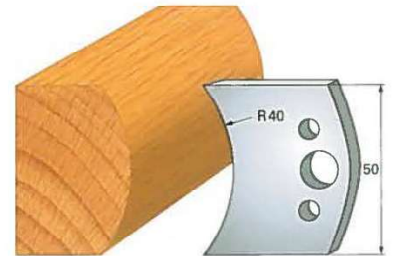

Art. SA2055 - (SA3055)



Art. SA2056 - (SA3056)

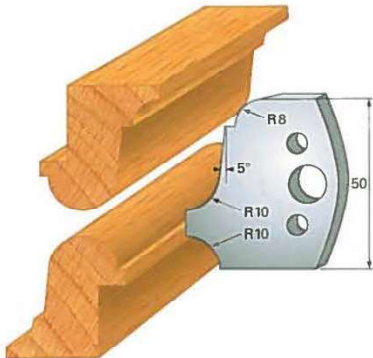

Art. SA2057 - (SA3057)

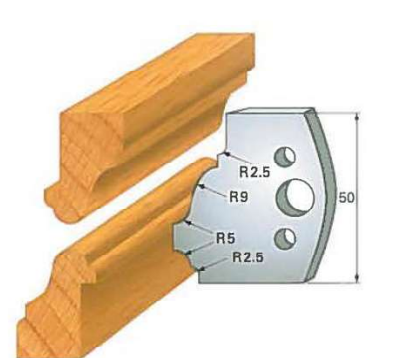

Art. SA2058 - (SA3058)

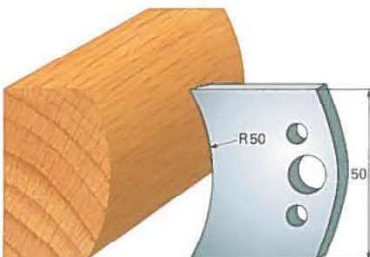

Art. SA2059 - (SA3059)



Art. SA2060 - (SA3060)



Art. SA2061 - (SA3061)

**STANDARD PROFILE KNIVES IN "SP" STEEL - height 50x4 mm  
(RELATING LIMITERS)**

**Example:  
Knife SA2..  
Limiter (SA3..)**

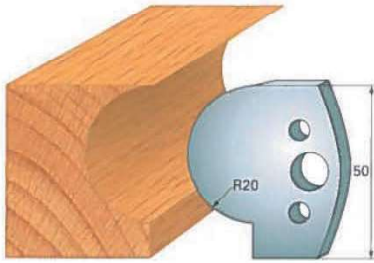

Art. SA2062 - (SA3062)

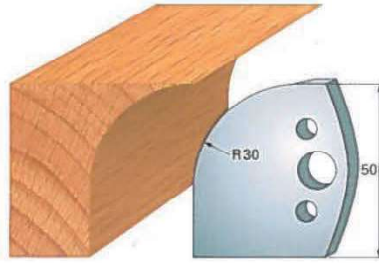

Art. SA2063 - (SA3063)

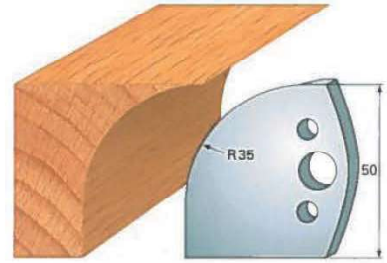

Art. SA2064 - (SA3064)

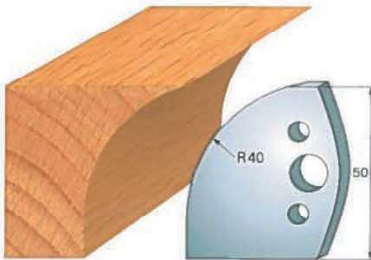

Art. SA2065 - (SA3065)

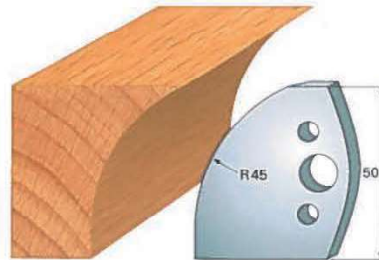

Art. SA20566 - (SA3066)



Art. SA2067 - (SA3067)

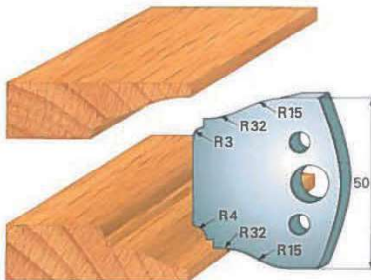

Art. SA2068 - (SA3068)

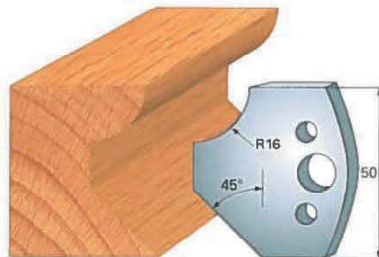

Art. SA2069 - (SA3069)

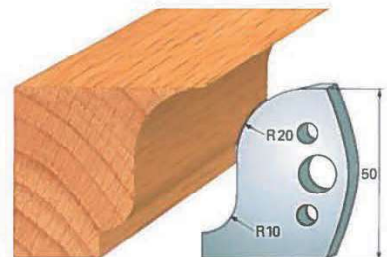

Art. SA2070 - (SA3070)

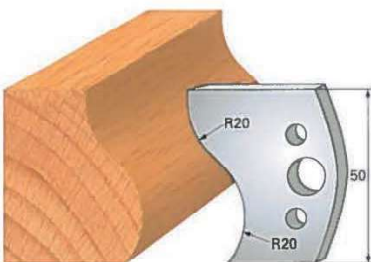

Art. SA2071 - (SA3071)

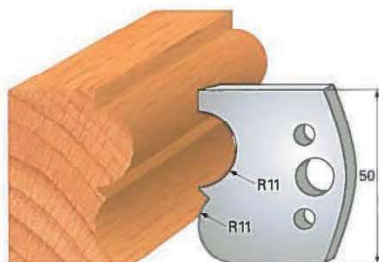

Art. SA20572 - (SA3072)



Art. SA20573 - (SA3073)

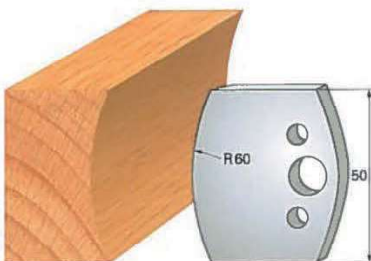

Art. SA2074 - (SA3074)

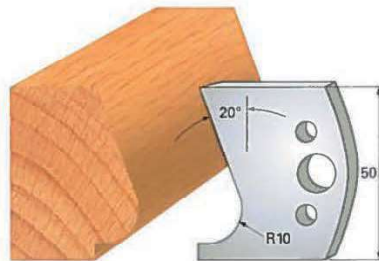

Art. SA2075 - (SA3075)

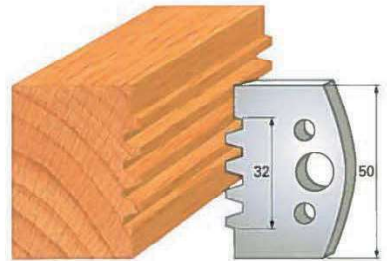

Art. SA2076 - (SA3076)

**STANDARD PROFILE KNIVES IN "SP" STEEL - height 50x4 mm  
(RELATING LIMITERS)**

**Example:  
Knife SA2..  
Limiter (SA3..)**

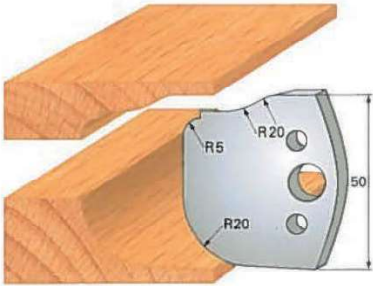

Art. SA2077 - (SA3077)

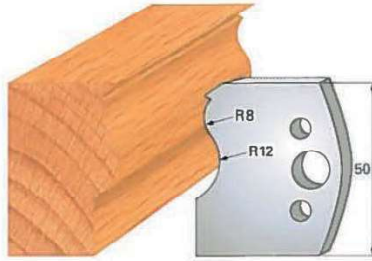

Art. SA2078 - (SA3078)

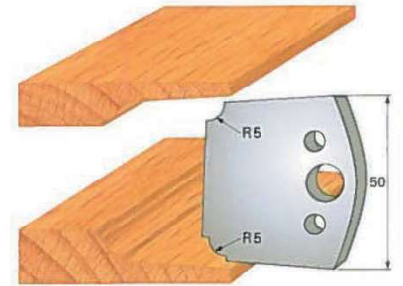

Art. SA2079 - (SA3079)

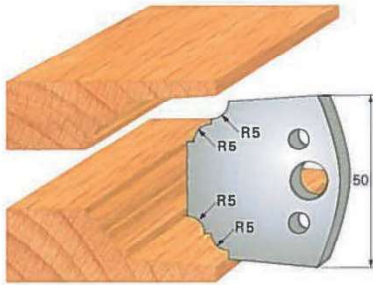

Art. SA2080 - (SA3080)